

UNESP - GESTÃO DO PLANO DIRETOR
PARTICIPATIVO DE SÃO LUIS DO PARAÍTINGA

ASSESSORIA TÉCNICA GRATUITA

GRUPO - Programa Unesp para o
desenvolvimento sustentável de São o Luís
do Paraítinga

METODOLOGIA

CONTATO

Realização de visitas para apreender necessidades de cada morador em relação a sua moradia e entorno

LEITURA

Entendimento das necessidades e problemas de cada morador

PROJETO

Após visitas e leitura de necessidades, entendemos a maioria dos problemas e apontamos algumas soluções que viabilizassem essas necessidades dos moradores com desenhos.



CASAS TÉRREAS

NECESSIDADE RELACIONADA A
ELEVAÇÃO DE MUROS DAS
FACHADAS: FRONTAIS,
LATERAIS E FUNDOS DE LOTE.

SOLUÇÕES ENCONTRADAS TENTAM MANTER A
PERMEABILIDADE DAS CASAS, POSSIBILITANDO O
RESGUARDO DE CADA MORADOR.

FORAM PENSADOS PROJETOS UTILIZANDO MATERIAIS COMO:

- MADEIRA
- METAL
- COBOGÓ (BLOCO COM CERTA TRANSPARÊNCIA)
- BLOCO DE CONCRETO
- FECHAMENTO VEGETAL

FECHAMENTO FRONTAL

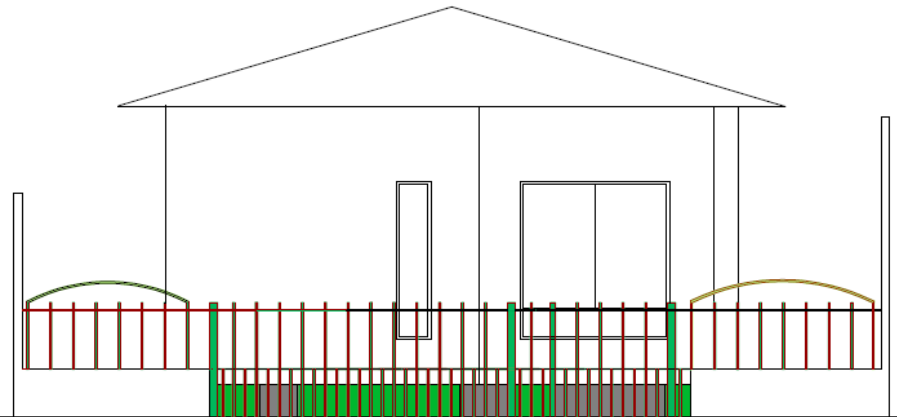
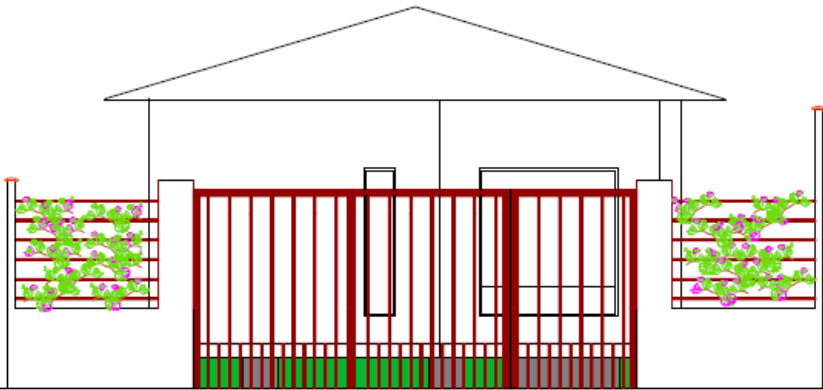
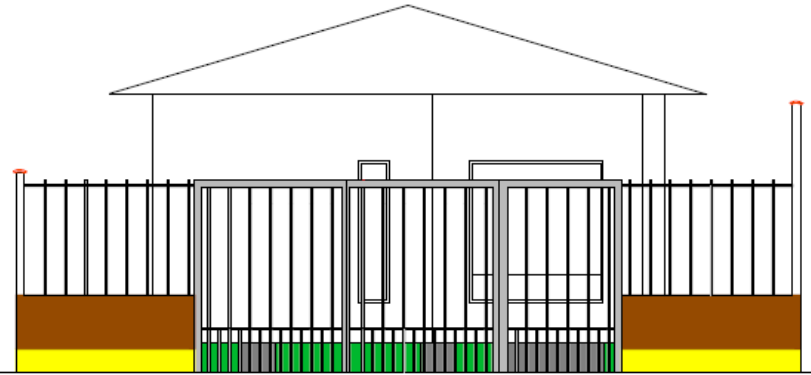
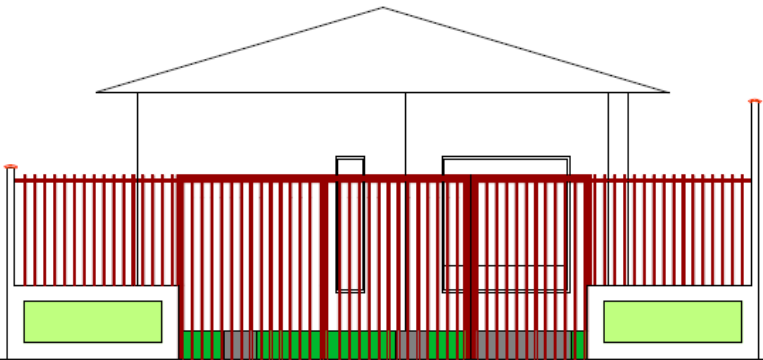

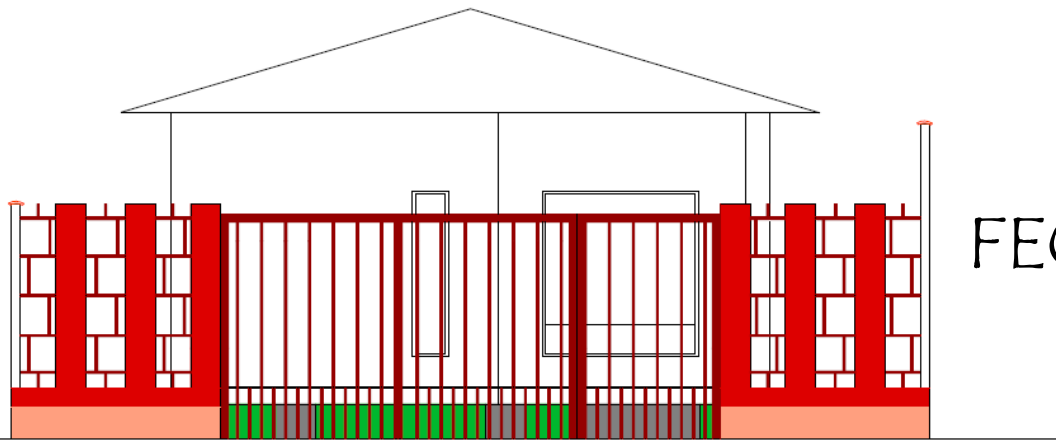

FECHAMENTO FRONTAL

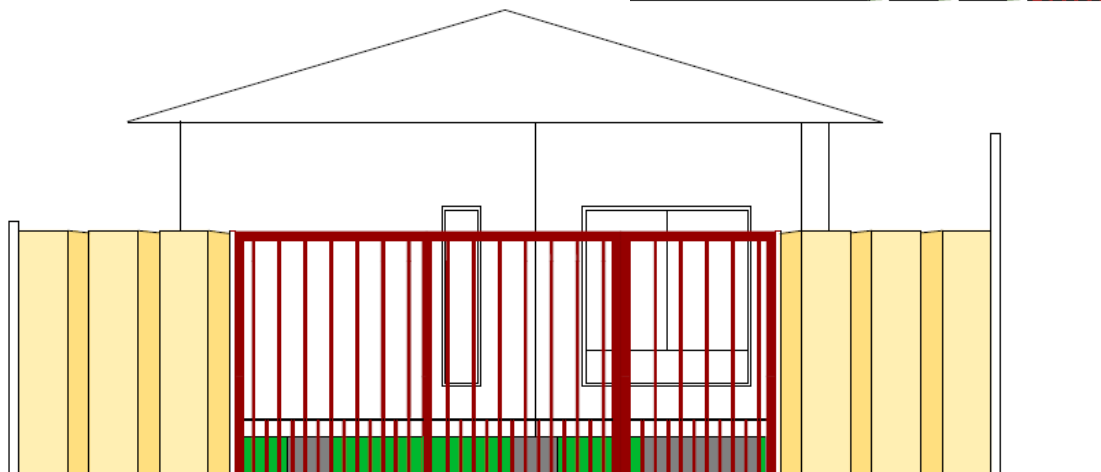
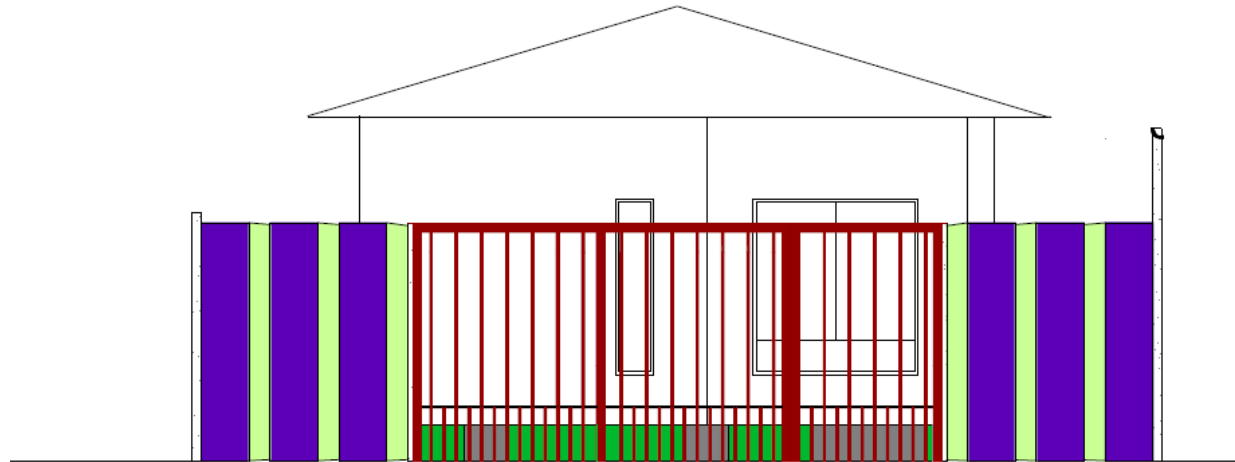

FECHAMENTO FRONTAL

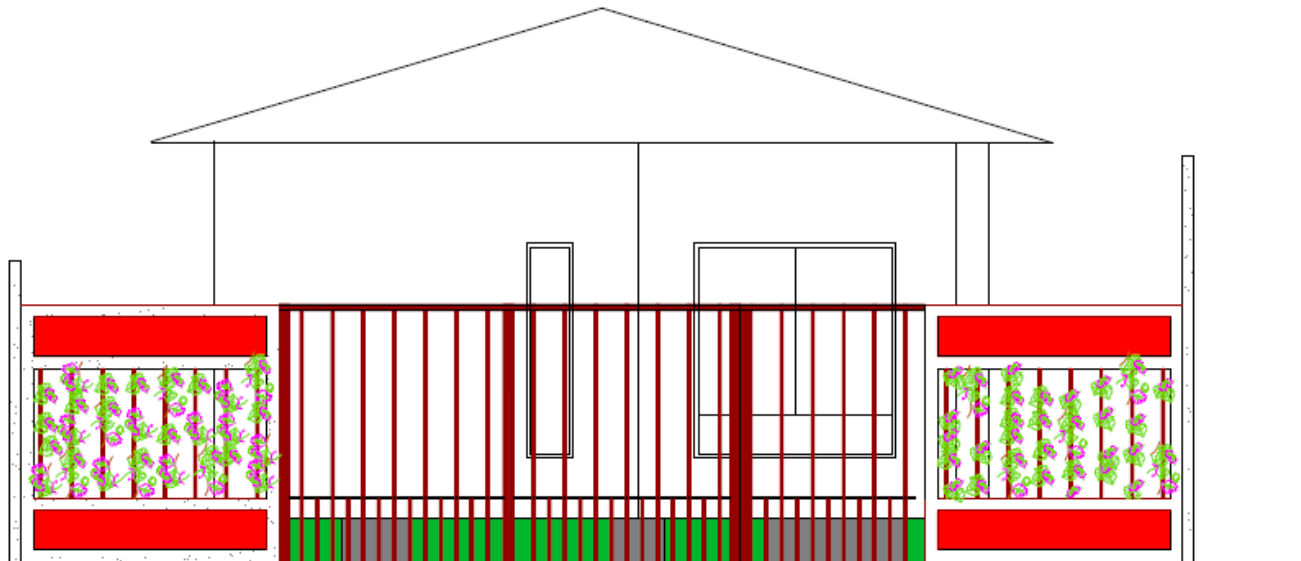
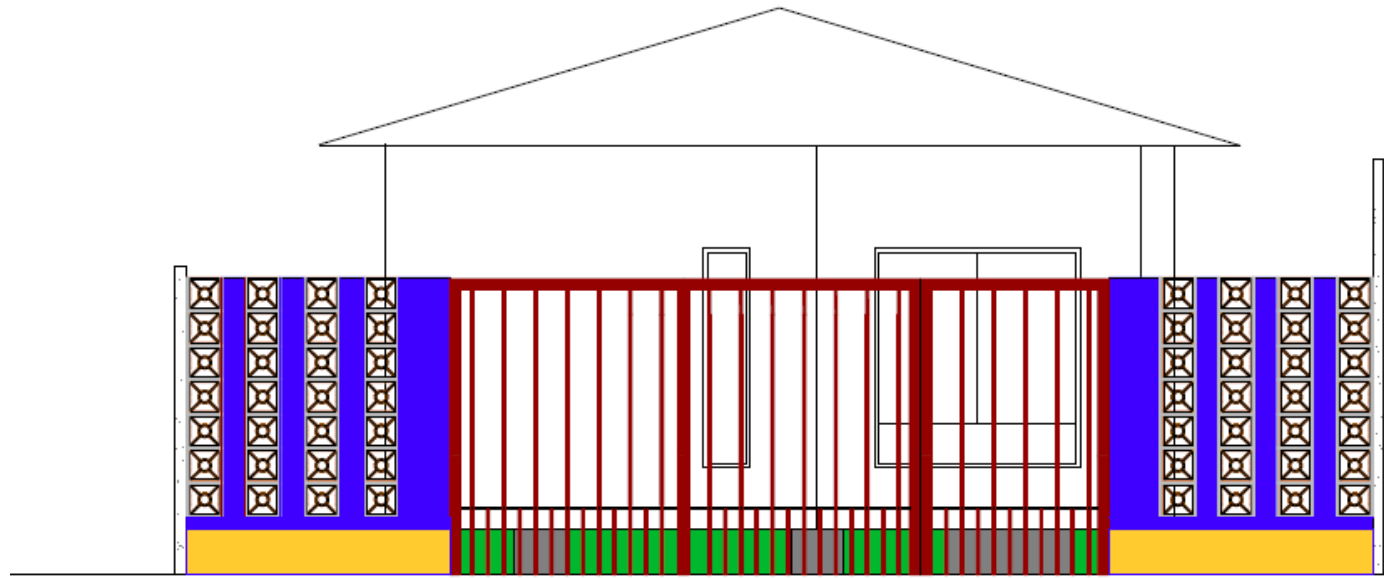

FECHAMENTO FRONTAL

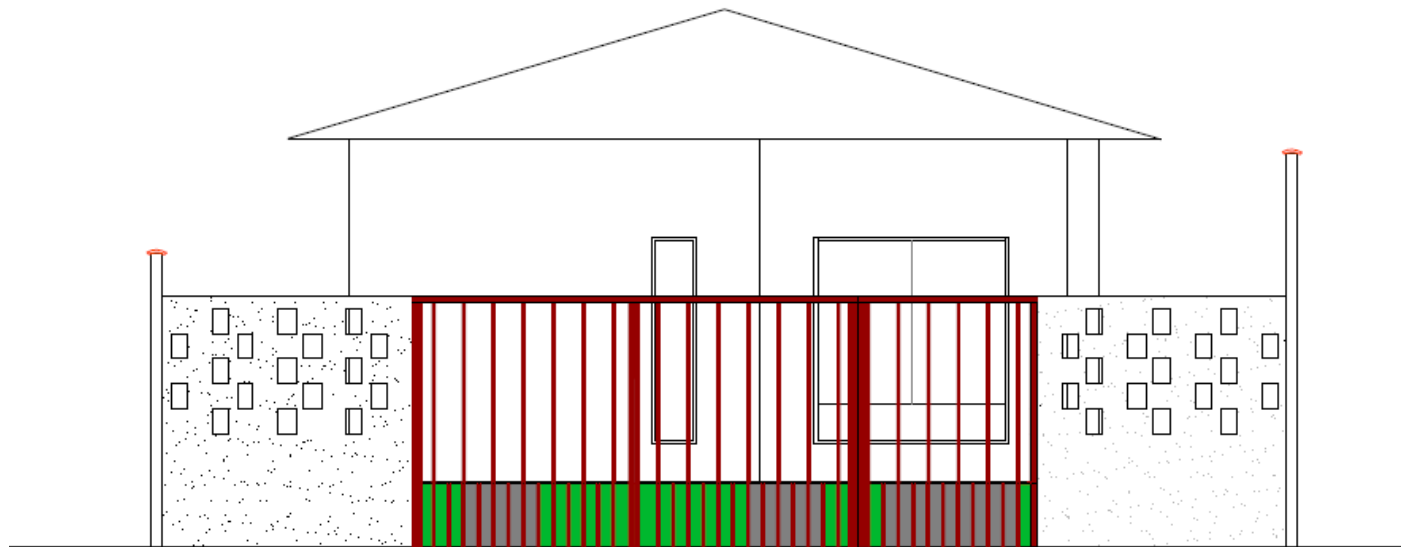
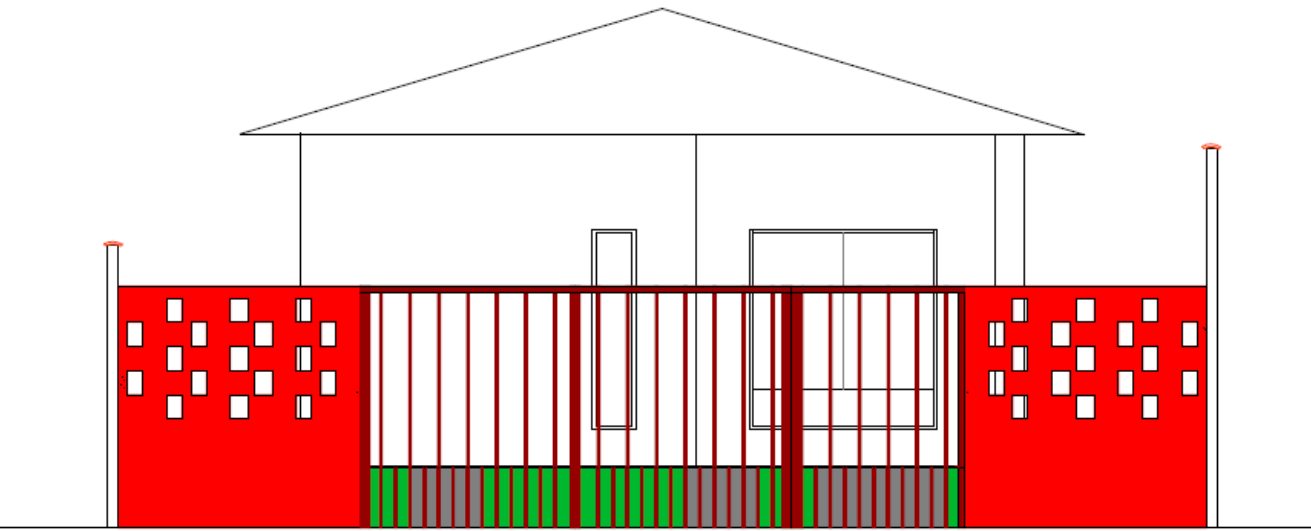

FECHAMENTO FRONTAL COM VEGETAÇÃO

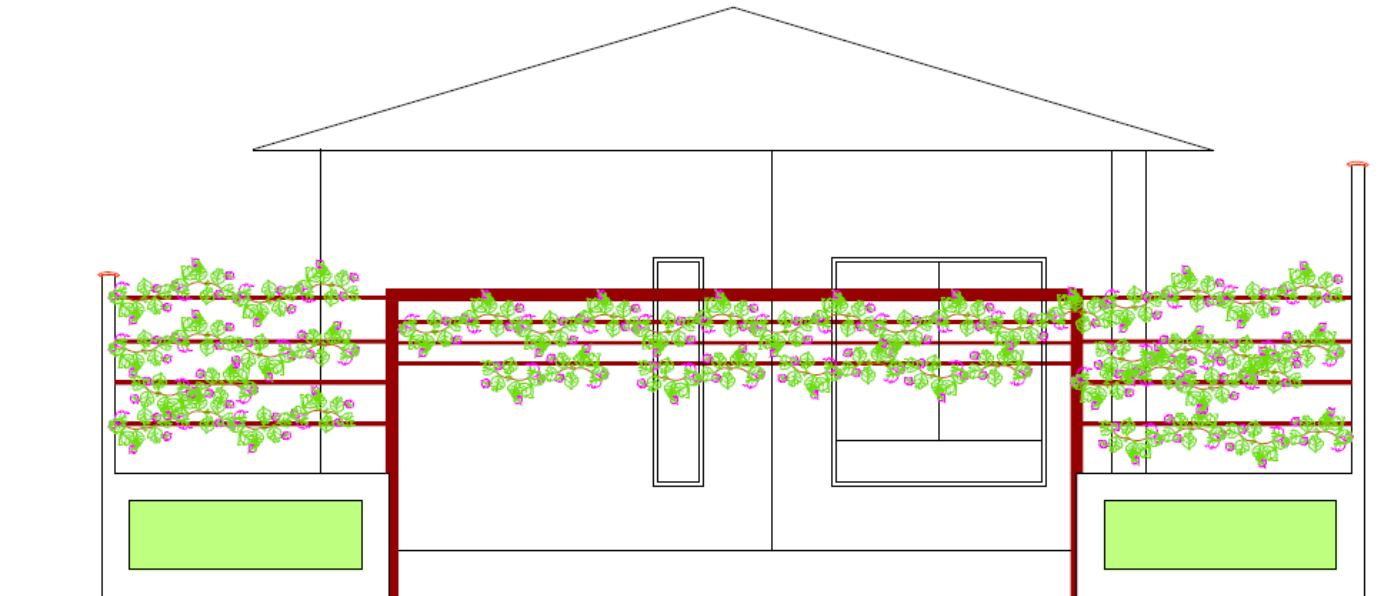
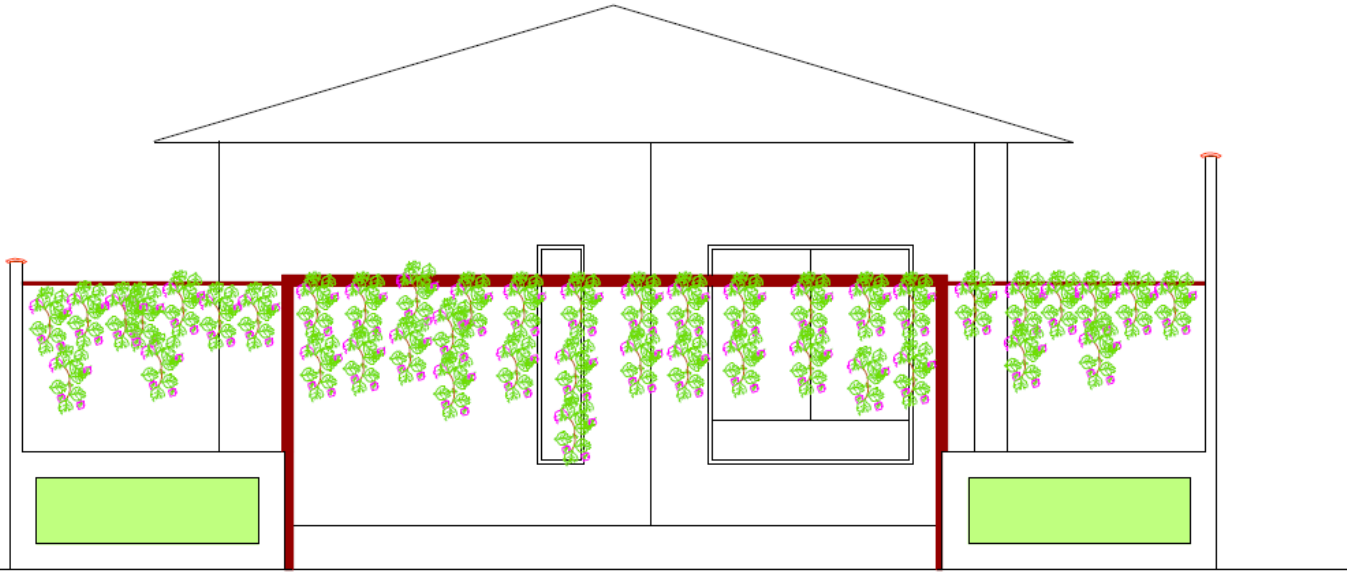

FECHAMENTO FRONTAL COM VEGETAÇÃO

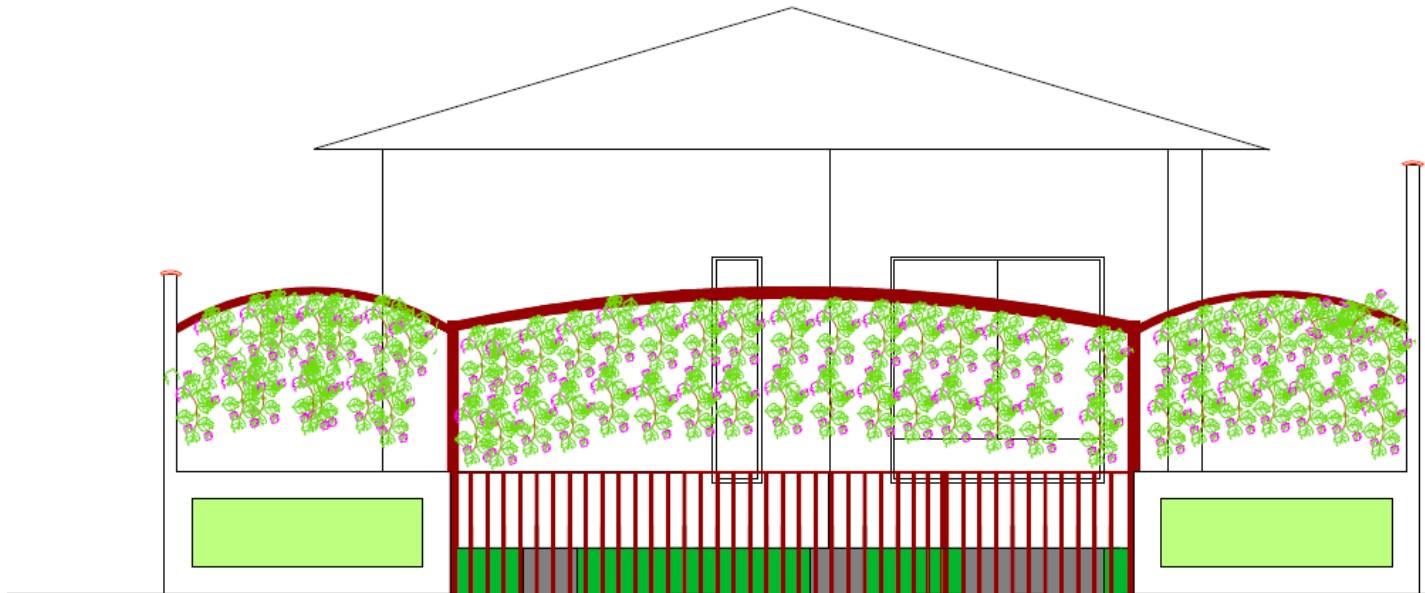
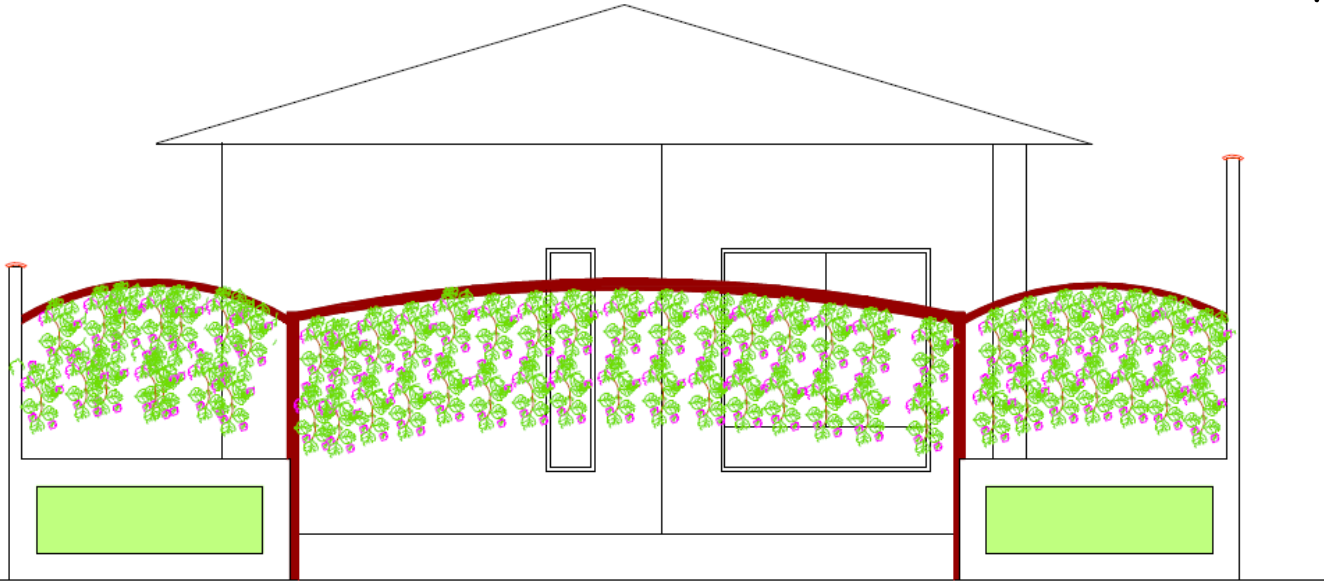

CASAS TÊRREAS FECHAMENTO LATERAL

SOLUÇÕES ENCONTRADAS TAMBÉM TENTAM MANTER A PERMEABILIDADE DAS CASAS, POSSIBILITANDO MAIOR VENTILAÇÃO E ENTRDA DE SOL

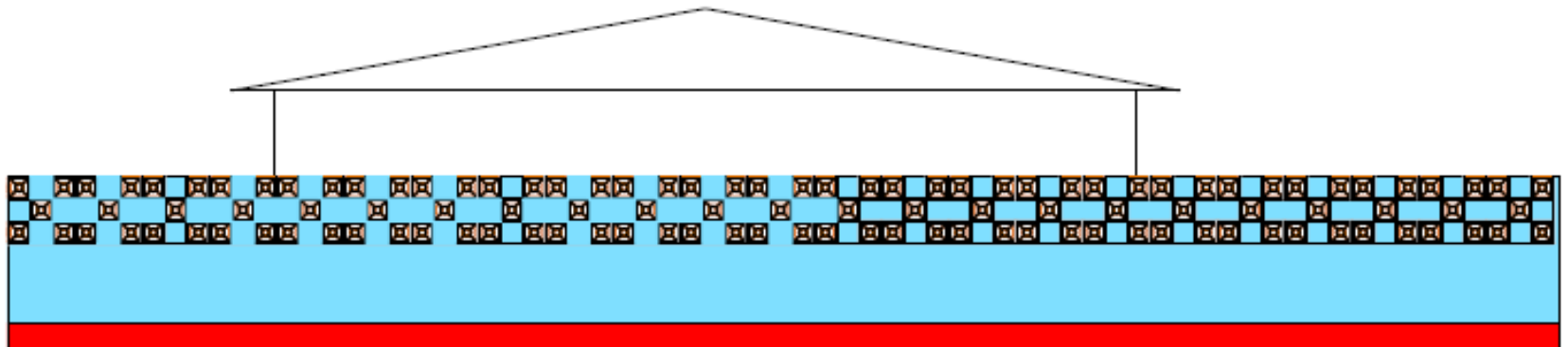
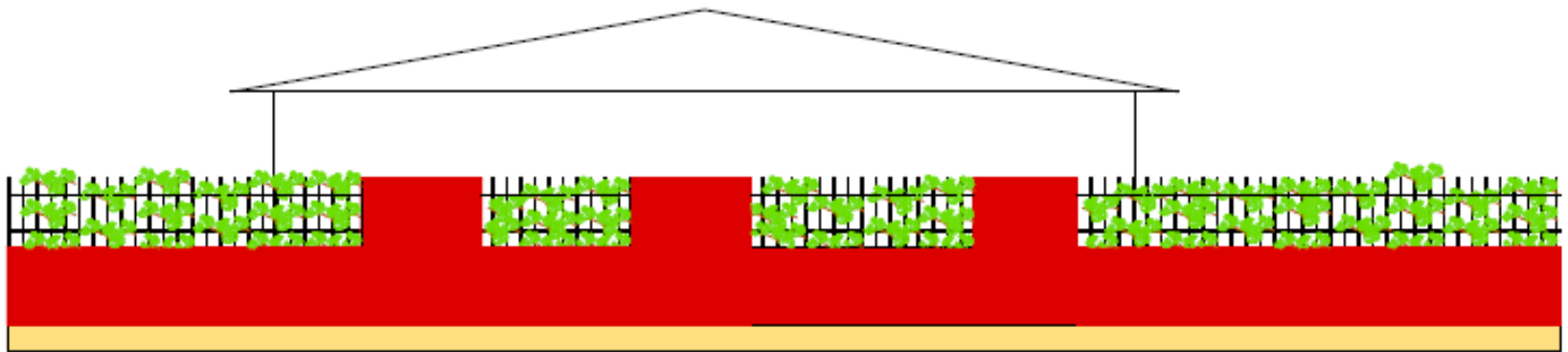

FECHAMENTO LATERAL

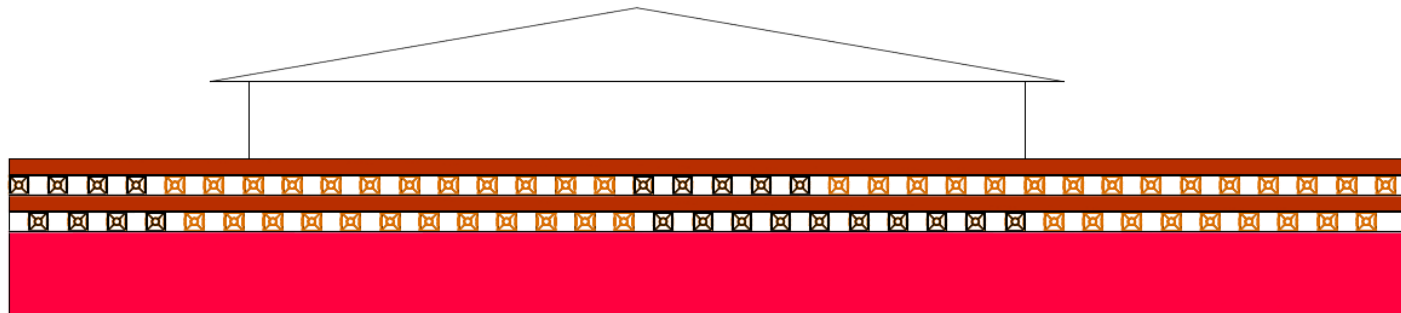
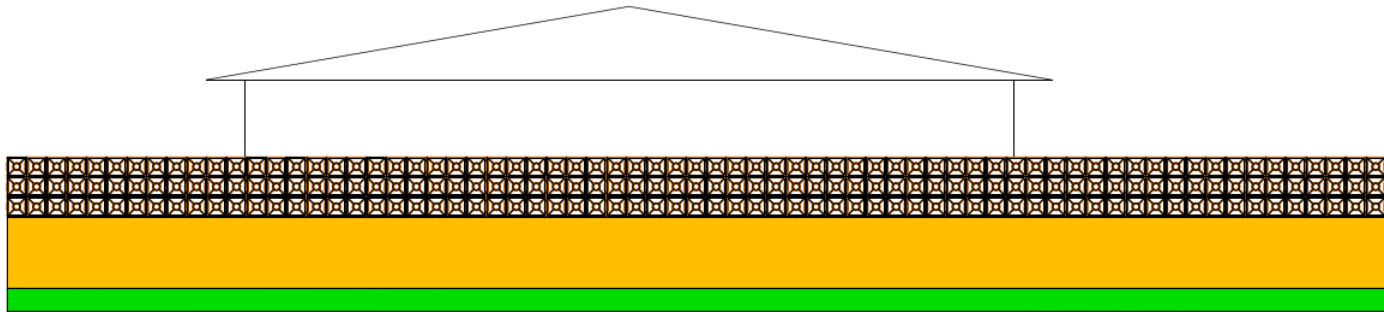
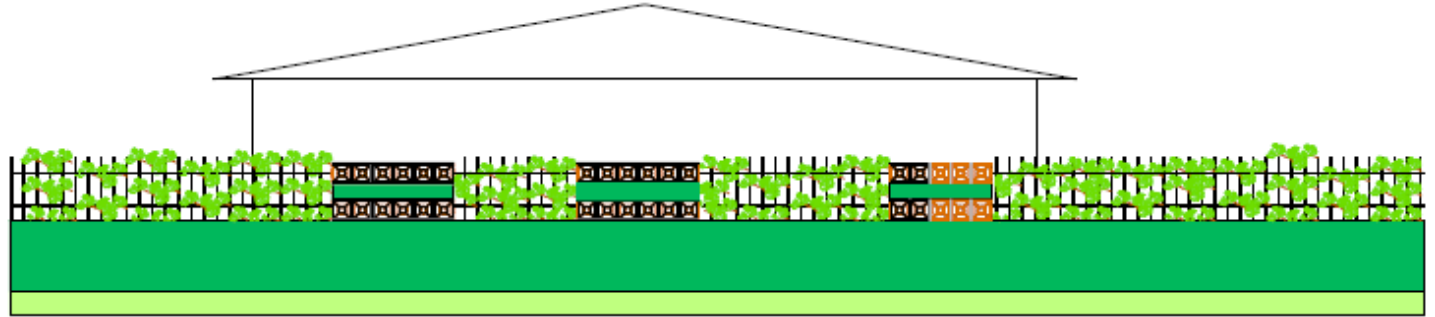

FECHAMENTO LATERAL

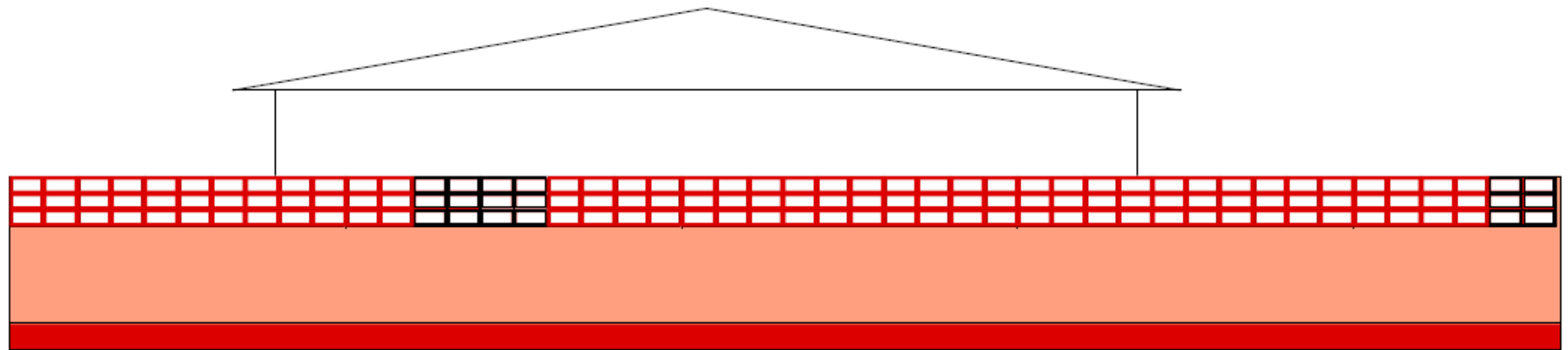
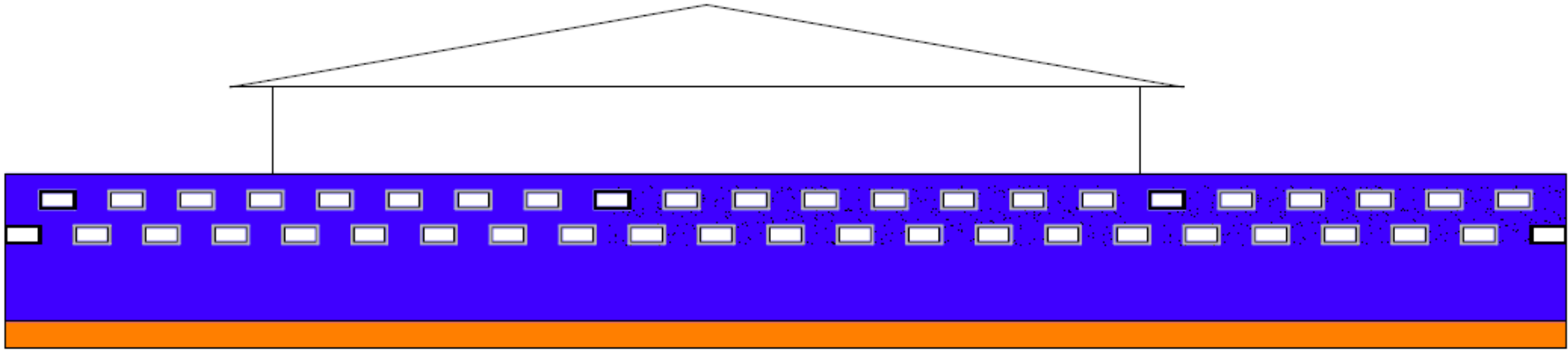

CASAS TÉRREAS

NECESSIDADE RELACIONADAS A VEDAÇÃO DAS GARAGENS.

SOLUÇÕES ENCONTRADAS PARA COBERTURAS COM TELHADOS DE DIVERSOS TIPOS ALÉM DE COBERTURAS LATERAIS COM PERGOLADOS

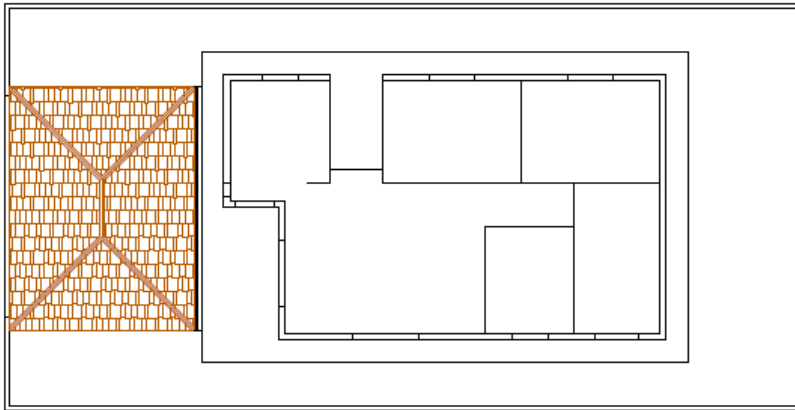

PLANTA

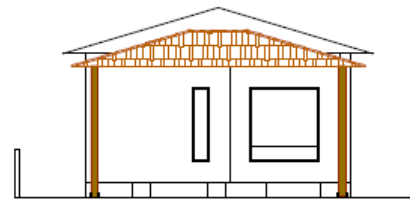

ELEVAÇÃO FRONTAL

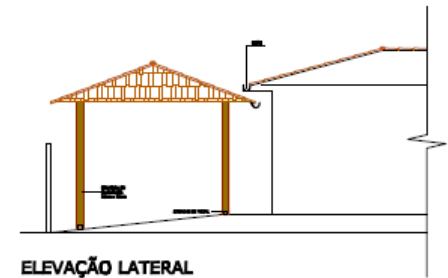

ELEVAÇÃO LATERAL

PERGOLADO DE MADEIRA

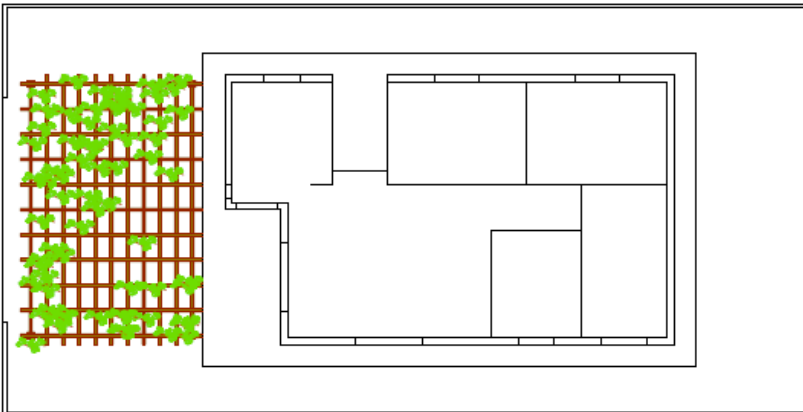

PLANTA



ELEVAÇÃO FRONTAL

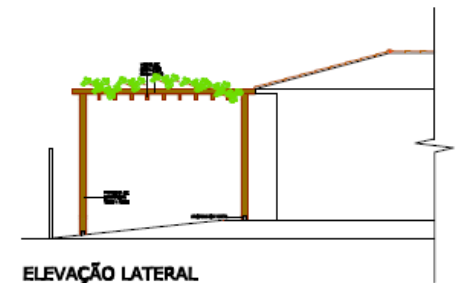

ELEVAÇÃO LATERAL

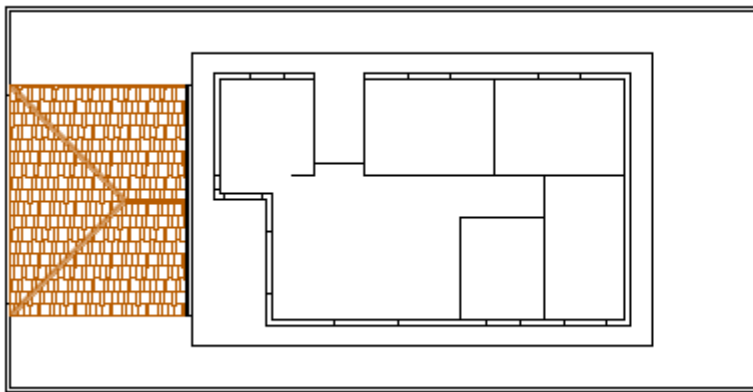

PLANTA

PERGOLADO DE MADEIRA

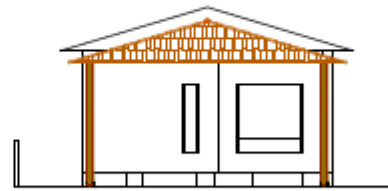

ELEVAÇÃO FRONTAL

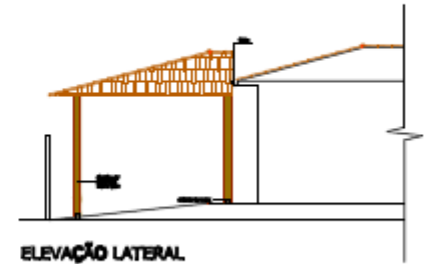

ELEVAÇÃO LATERAL

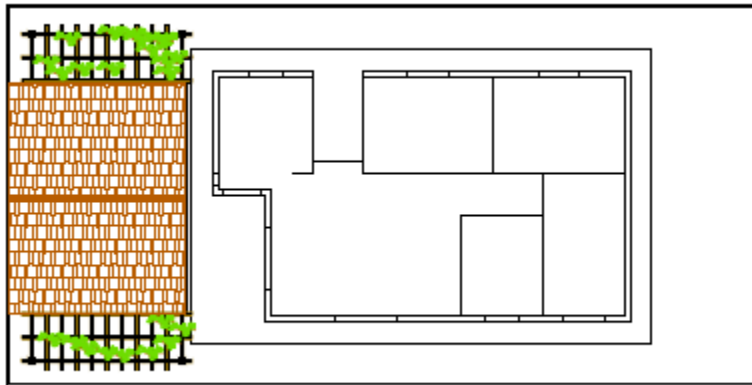

PLANTA

PERGOLADO DE MADEIRA



ELEVAÇÃO FRONTAL

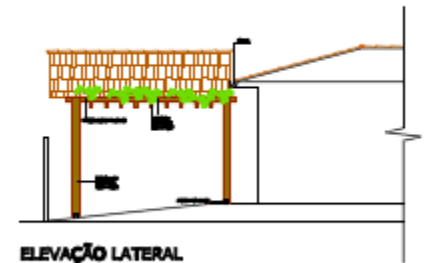

ELEVAÇÃO LATERAL

TELHA FIBROCIMENTO

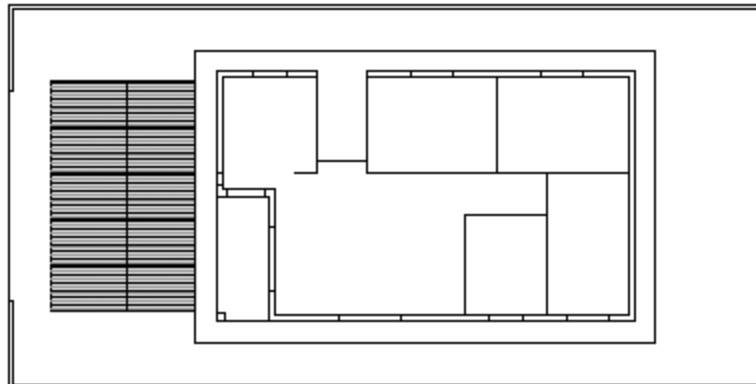

ELEVAÇÃO FRONTAL

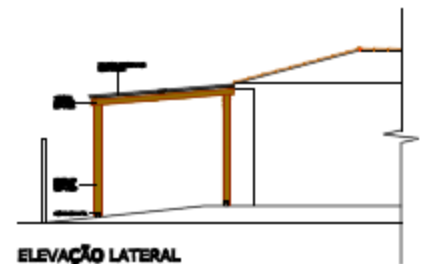

ELEVAÇÃO LATERAL

CASAS TÉRREAS

NECESSIDADE RELACIONADA A AMPLIAÇÃO (CÔMODOS) NOS FUNDOS DE LOTE

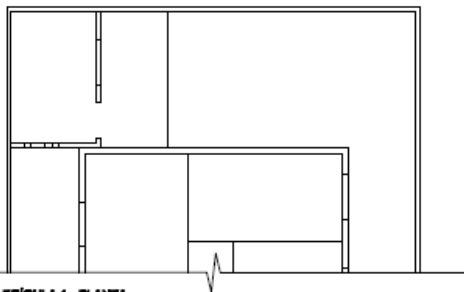

EDÍCULA 1 - PLANTA

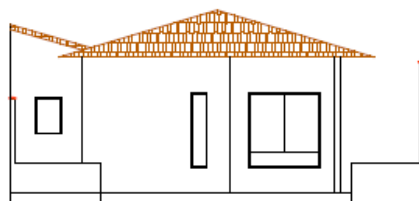

EDÍCULA 1 - ELEVAÇÃO FRONTAL

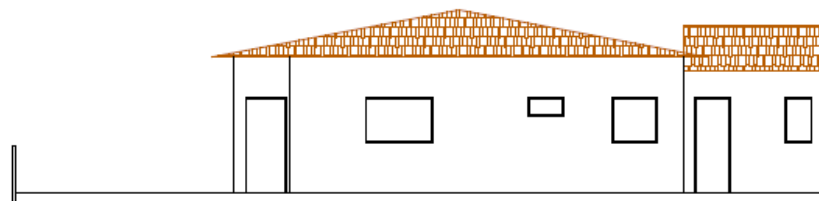

EDÍCULA 1 - ELEVAÇÃO LATERAL

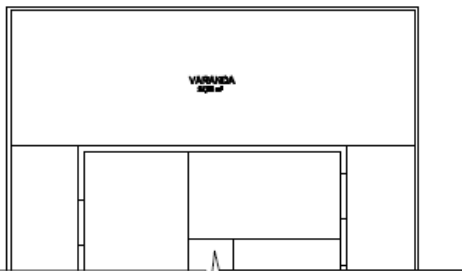

EDÍCULA 3 - PLANTA

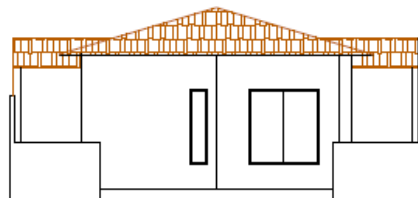

EDÍCULA 3 - ELEVAÇÃO FRONTAL

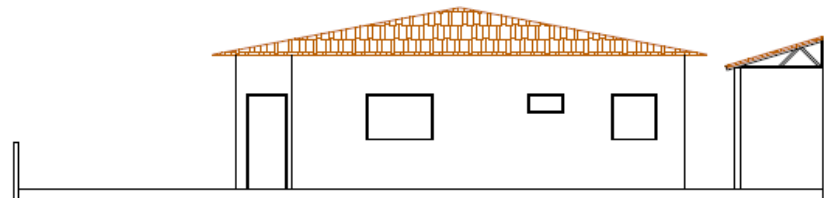

EDÍCULA 3 - ELEVAÇÃO LATERAL

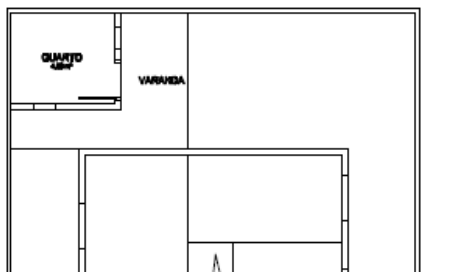

EDÍCULA 2

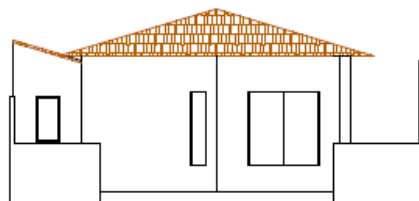

EDÍCULA 2 - ELEVAÇÃO FRONTAL

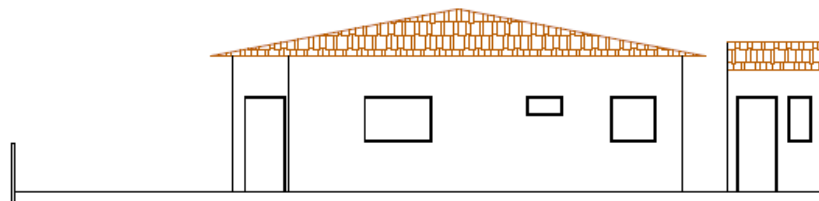

EDÍCULA 2 - ELEVAÇÃO LATERAL

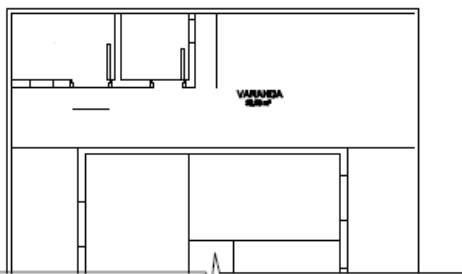

EDÍCULA 4 - PLANTA

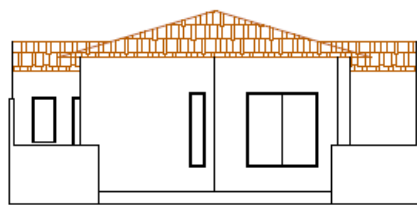

EDÍCULA 4 - ELEVAÇÃO FRONTAL

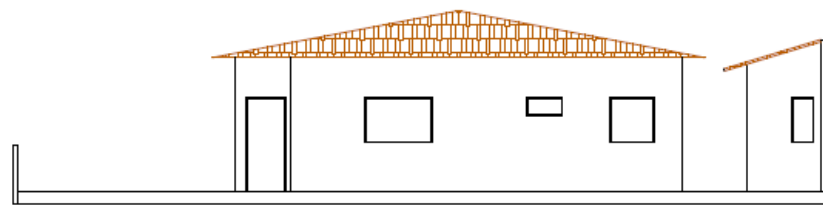

EDÍCULA 4 - ELEVAÇÃO LATERAL

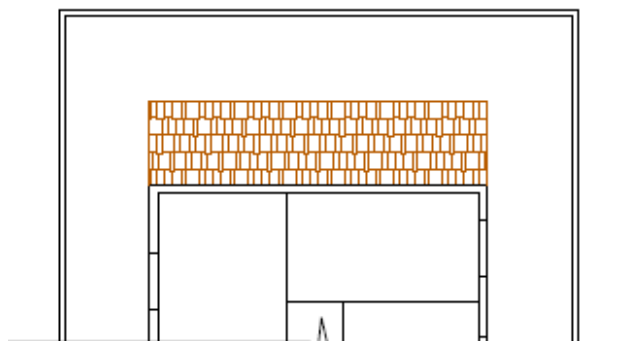

EDÍCULA 5 - PLANTA

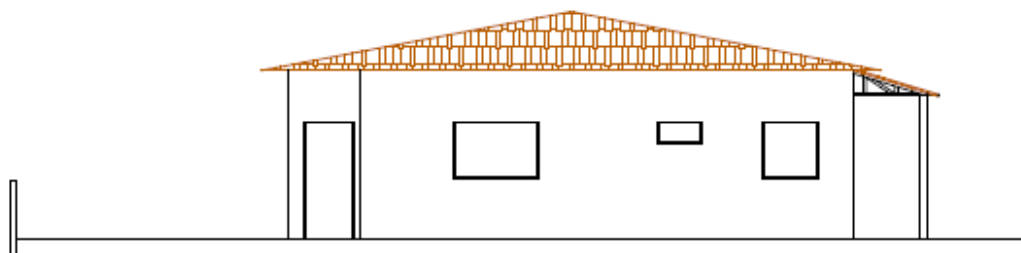

EDÍCULA 5 - ELEVAÇÃO LATERAL

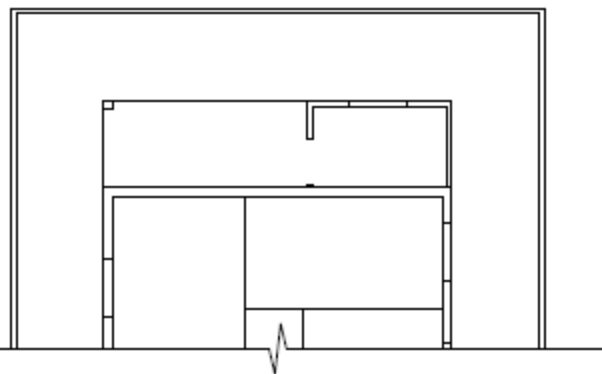

EDÍCULA 6 - PLANTA

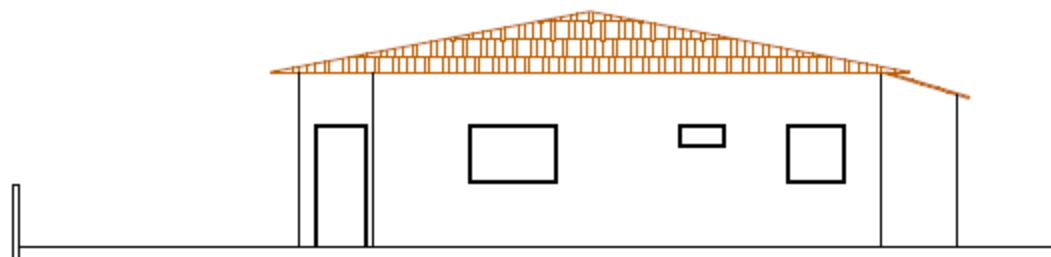

EDÍCULA 6 - ELEVAÇÃO LATERAL

CASAS SOBRADO

NECESSIDADE RELACIONADA A ELEVÇÃO DE MUROS DAS FACHADAS: FRONTAIS, E FUNDOS DE LOTE, ALÉM DE AMPLIAÇÕES NO FUNDO DE LOTE

SOLUÇÕES ENCONTRADAS TENTAM MANTER TAMBÉM A PERMEABILIDADE DAS CASAS, POSSIBILITANDO O RESGUARDO DE CADA MORADOR.

FORAM PENSADOS PROJETOS UTILIZANDO MATERIAIS COMO:

- MADEIRA
- METAL
- COBOGÓ (BLOCO COM CERTA TRANSPARÊNCIA)
- BLOCO DE CONCRETO

EXEMPLOS DE FECHAMENTO POSTERIOS DOS SOBRADOS, COM COBERTURA DA LAVANDERIA

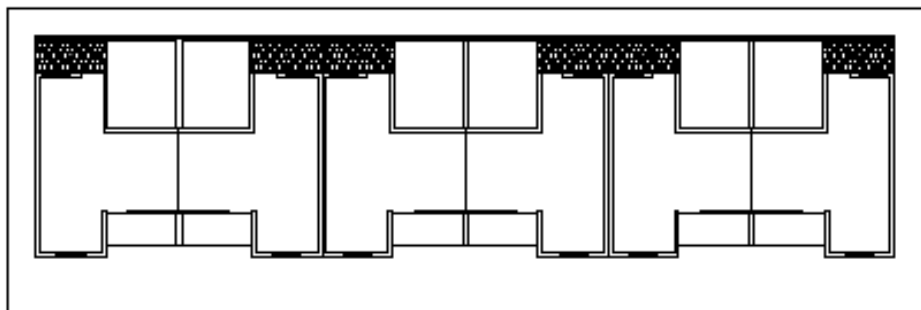

TÉRREO

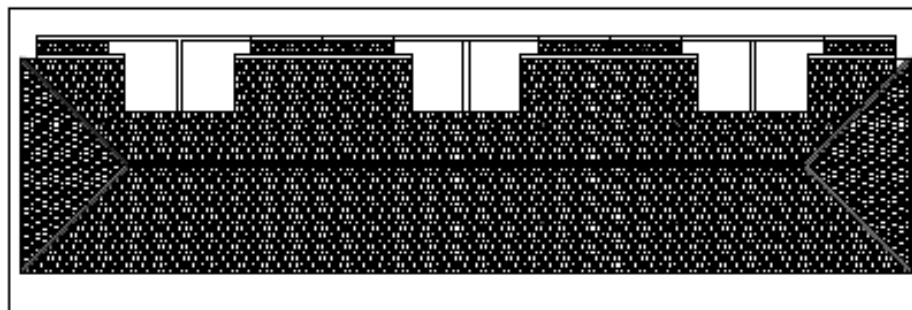

COBERTURA

ELEVAÇÕES

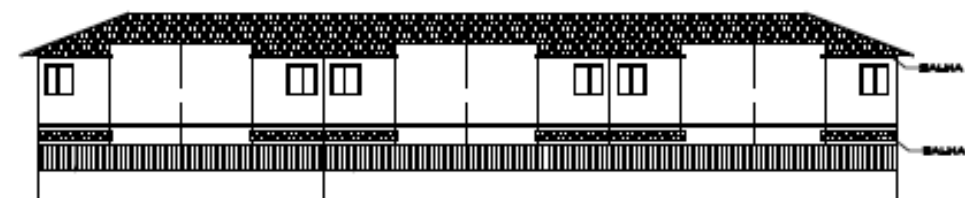

PROPOSTA 4 - MURO COM GRADE DE MADEIRA INCLINADA - LUMINOSIDADE/ TELHADO DO RANCHO COM QUEDA PARA CALHA/ CALHA NO TELHADO DO SOBRADO

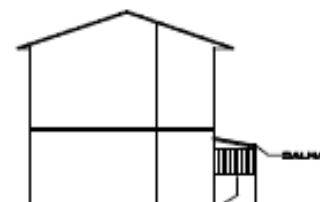
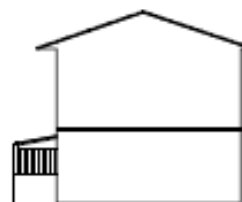
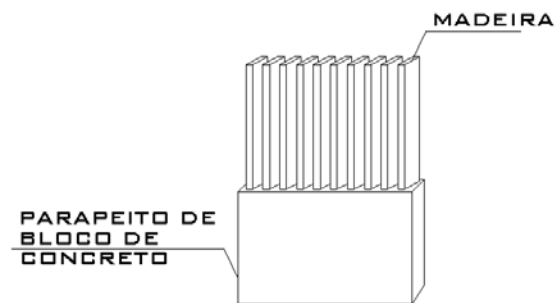

MURO INTERMEDIÁRIO COM BRASE DE MADEIRA INCLINADA

EXEMPLOS DE FECHAMENTO POSTERIORES DOS SOBRADOS, COM COBERTURA DA LAVANDERIA

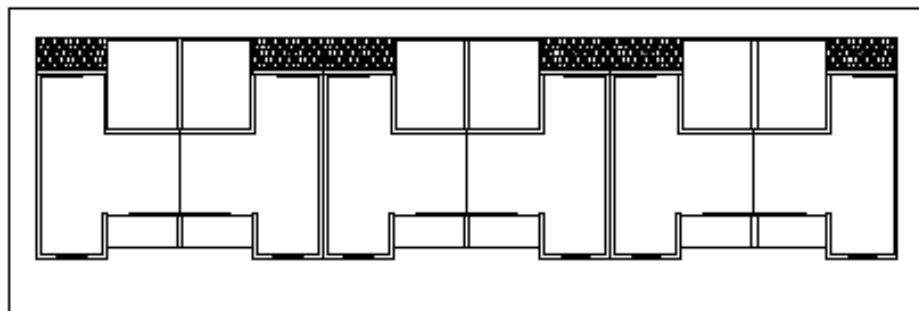

TÉRREO

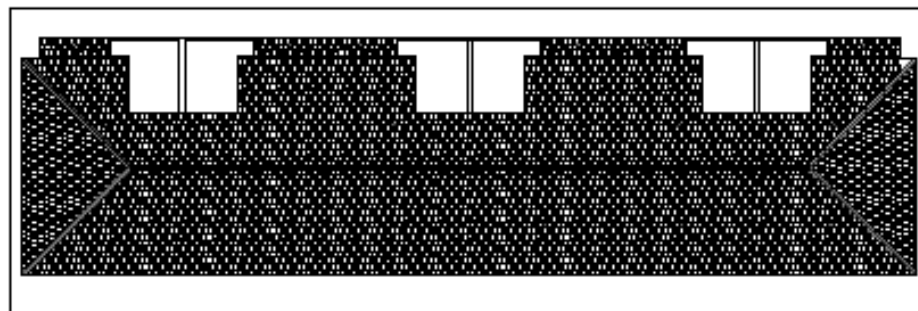

COBERTURA

ELEVAÇÕES

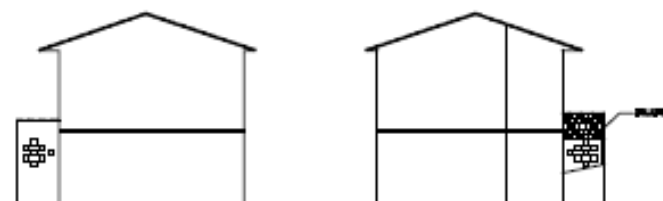
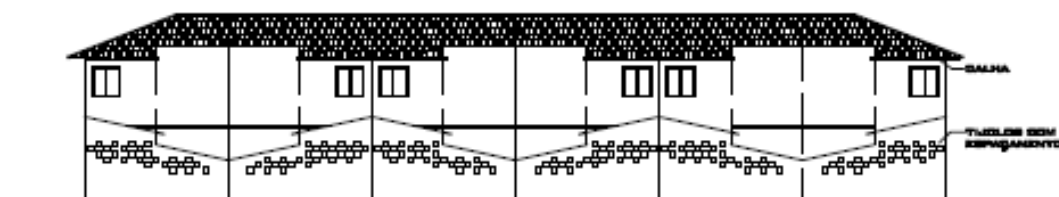

PROPOSTA 3 - TIJOLOS COM ESPAÇAMENTO, QUEDA PARA O QUINTAL E MURO DEGRASCENTE/ CALHA NO TELHADO DO SOBRADO

EXEMPLOS DE FECHAMENTO POSTERIORES DOS SOBRADOS, COM COBERTURA DA LAVANDERIA

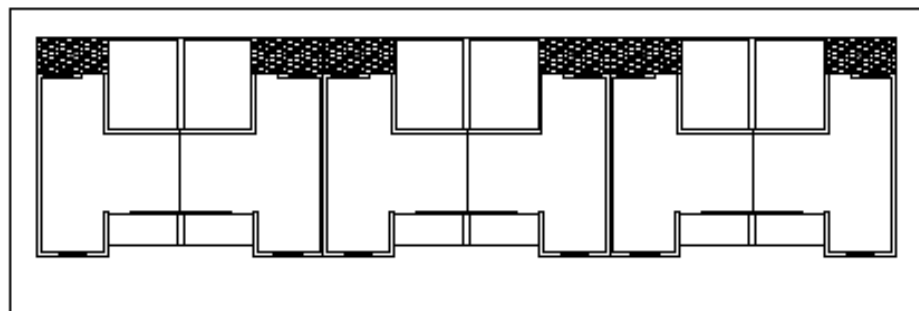

TÉRREO

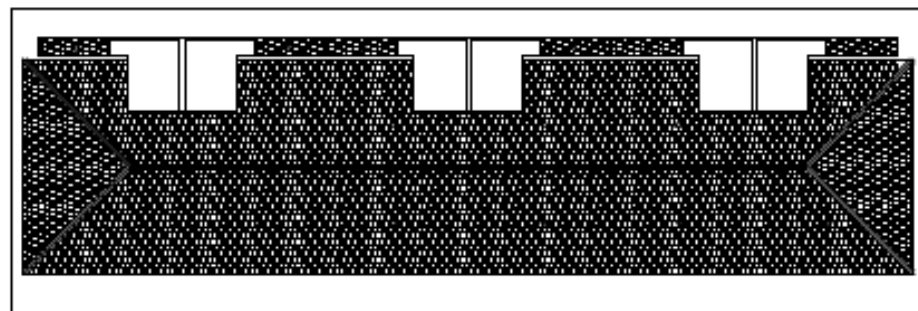

COBERTURA

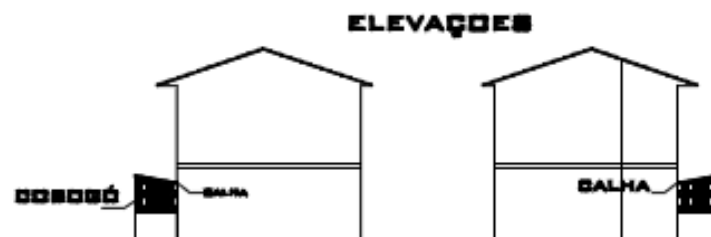
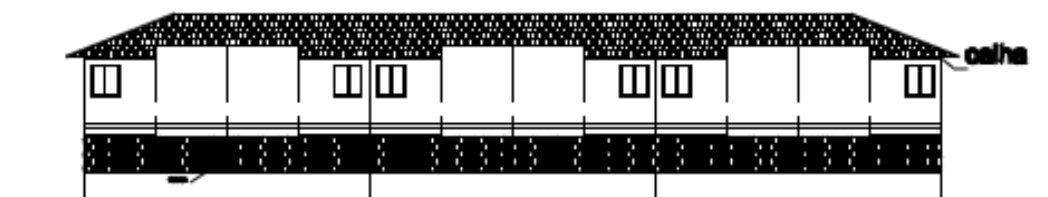

PROPOSTA 1 - MURO COM COBOGÓ - LUMINOSIDADE/ TELHADO DO RANCHO COM QUEDA PARA CALHA (DENTO) / CALHA NO TELHADO DO SOBRADO

EXEMPLOS DE FECHAMENTO POSTERIOS DOS SOBRADOS, COM COBERTURA DA LAVANDERIA

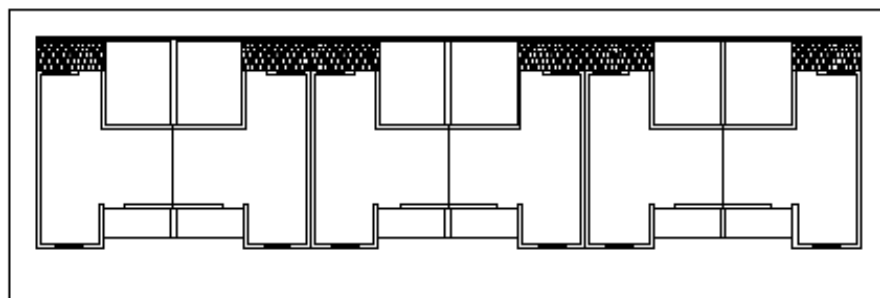

TÉRREO

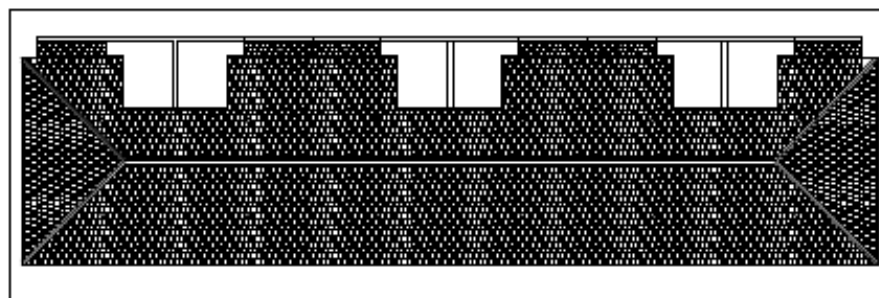

COBERTURA

ELEVAÇÕES

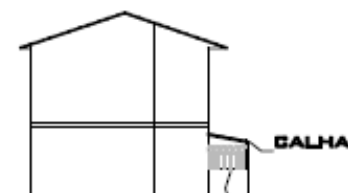
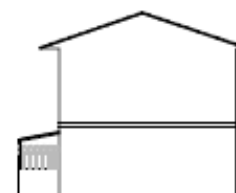
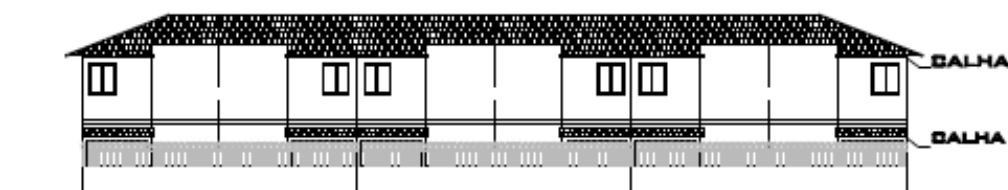

MURO INTERMEDIÁRIO COM GRADE

PROPOSTA 2 - MURO COM VERBALHÕES - LUMINOSIDADE/ TELHADO DO RANCHO COM QUEDA PARA CALHA (FORA)/ CALHA NO TELHADO DO SOBRADO

EXEMPLOS DE FECHAMENTO FRONTAL DOS SOBRADOS

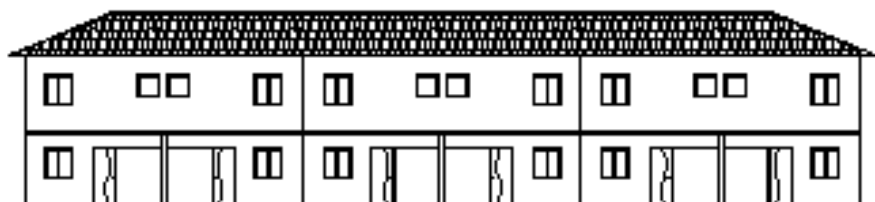

ORIGINAL



EXEMPLO 1

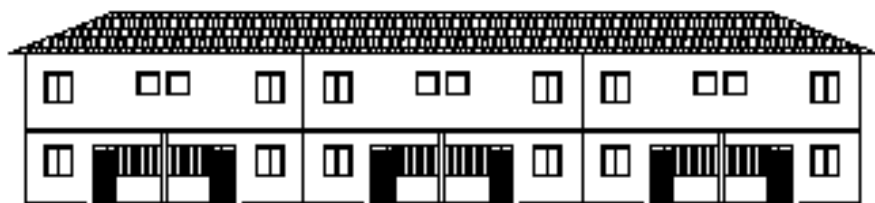
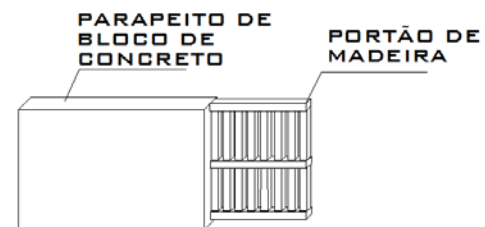

EXEMPLO 2

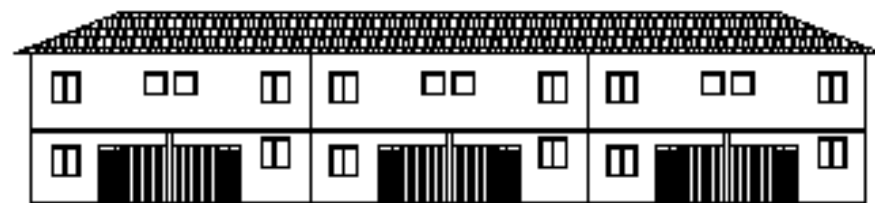
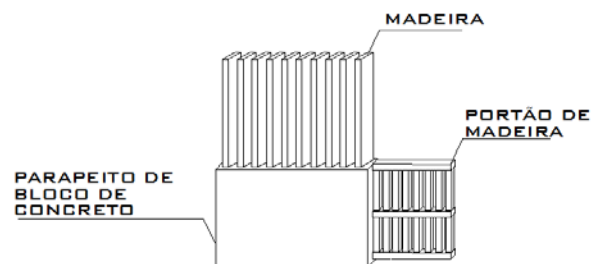

EXEMPLO 3

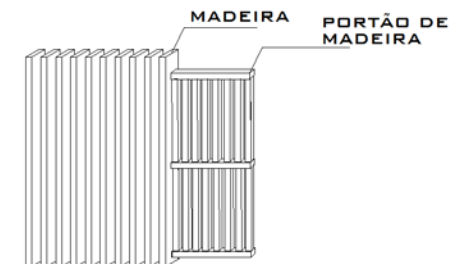

EXEMPLOS DE FECHAMENTO FRONTAL DOS SOBRADOS

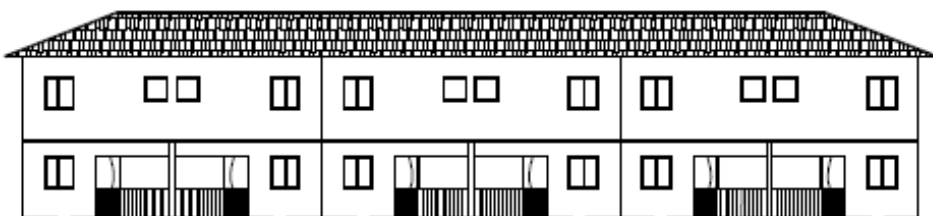

EXEMPLO 4

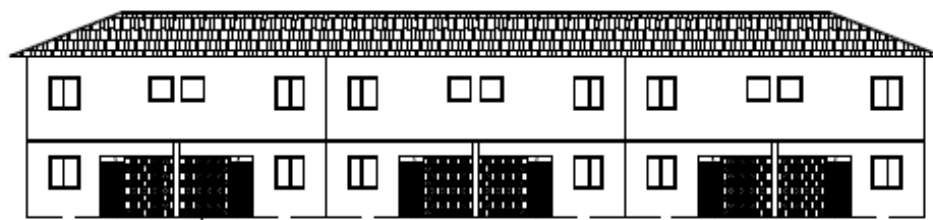
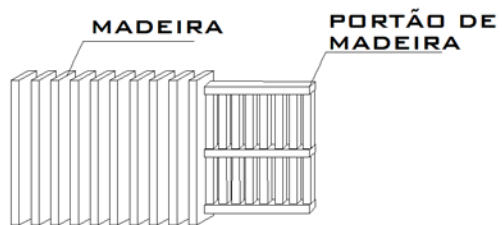

EXEMPLO 5

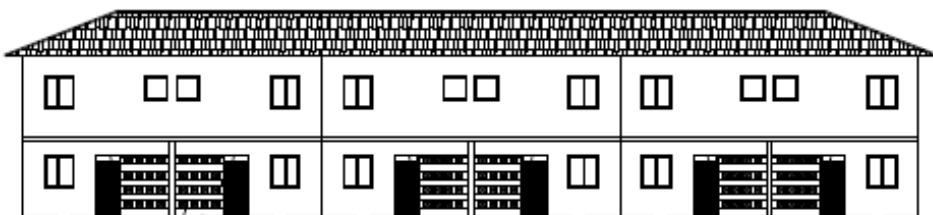
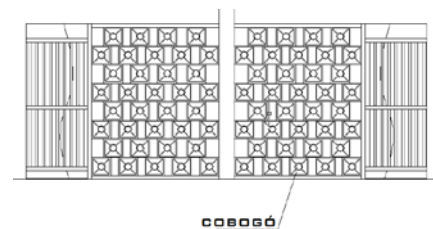

EXEMPLO 6

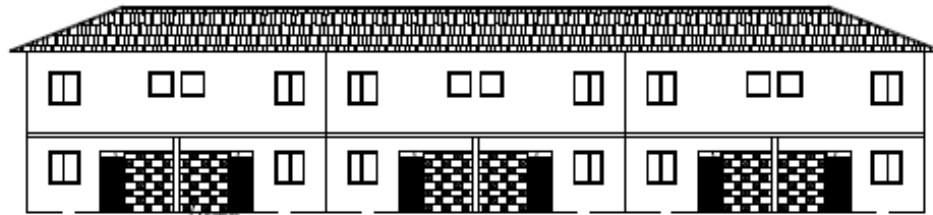
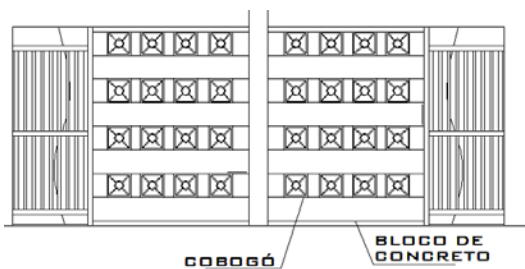

EXEMPLO 7

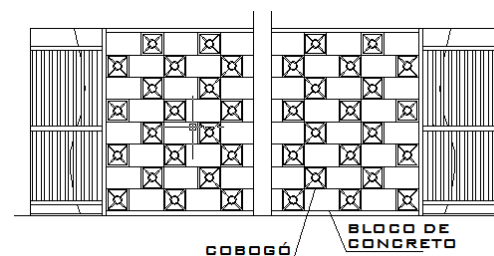

EXEMPLO DE FECHAMENTO POSTERIOS DOS SOBRADOS, COM COBERTURA DA PORTA DA COZINHA E TERRAÇO COBERTO

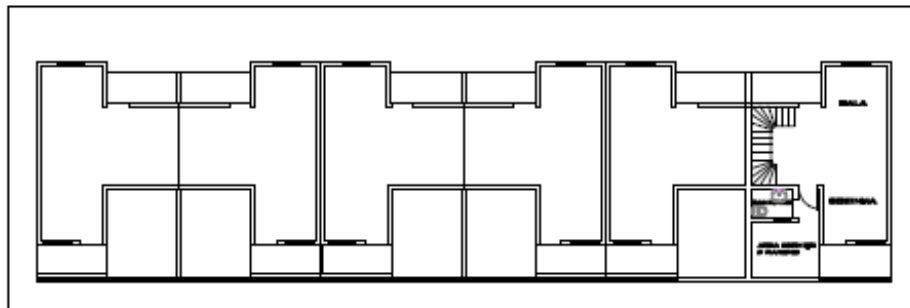

TÉRREO

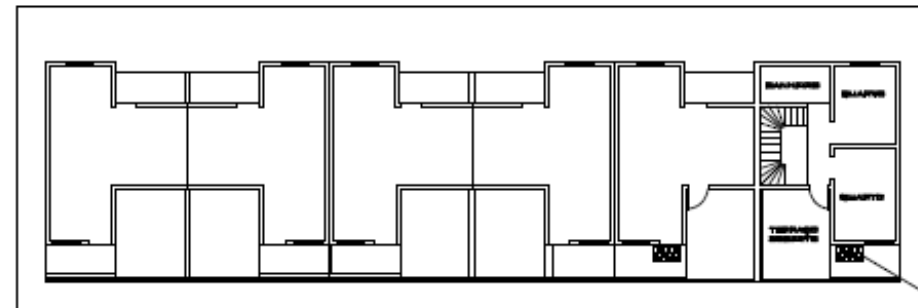

1 PAVIMENTO

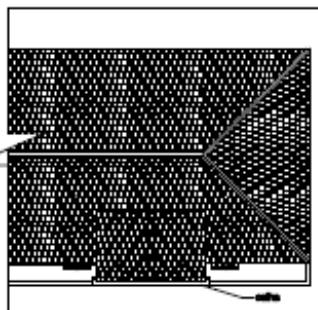

COBERTURA

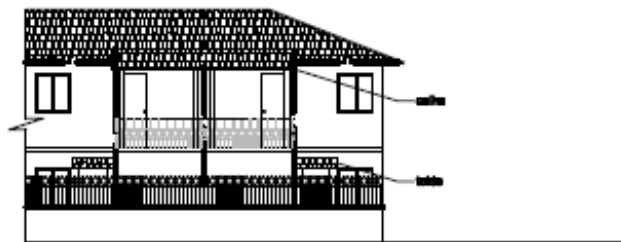

FACHADA POSTERIOR

ELEVAÇÕES

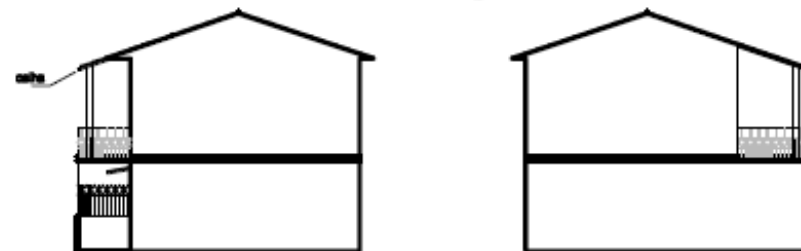

EXEMPLO DE FECHAMENTO POSTERIORES DOS SOBRADOS, COM COBERTURA DA PORTA DA COZINHA E QUARTO EXTRA

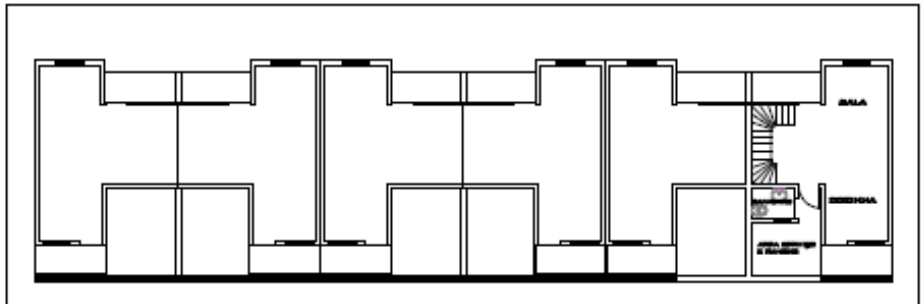

TÉRREO

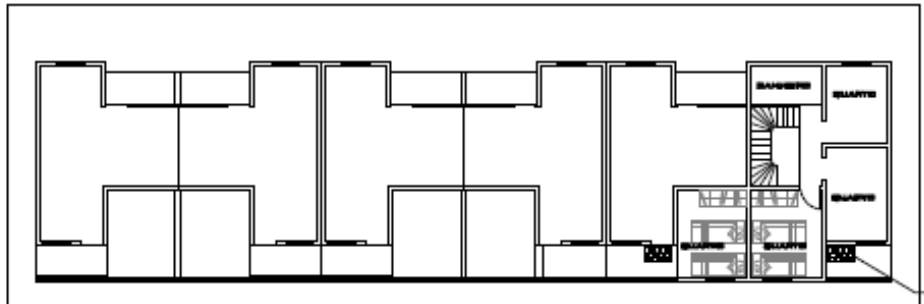

1 PAVIMENTO

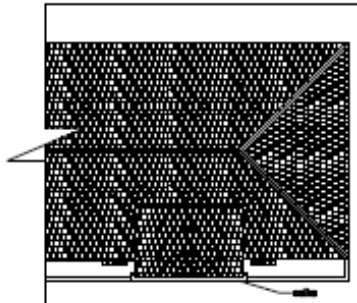

COBERTURA



FACHADA POSTERIOR

ELEVAÇÕES

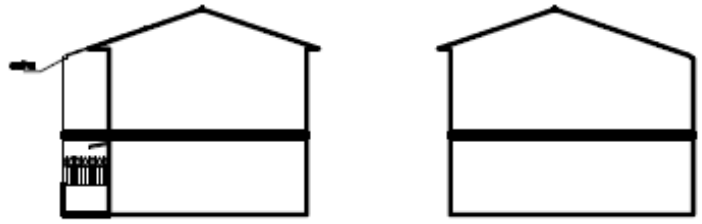

EXEMPLO DE FECHAMENTO POSTERIOR DOS SOBRADOS, COM COBERTURA DA ÁREA DE SERVIÇO, ADIÇÃO DE BANHEIRO E TERRAÇO

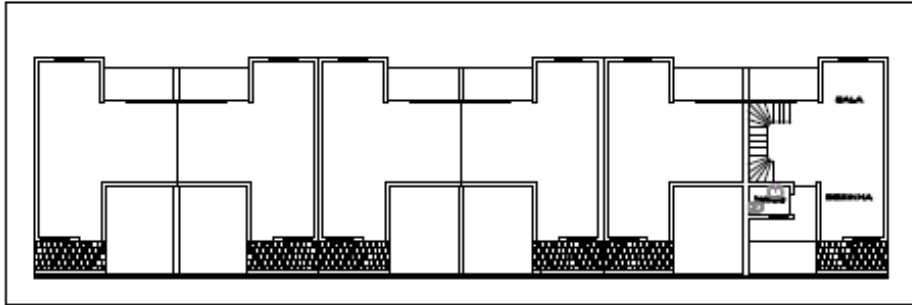

TÉRREO

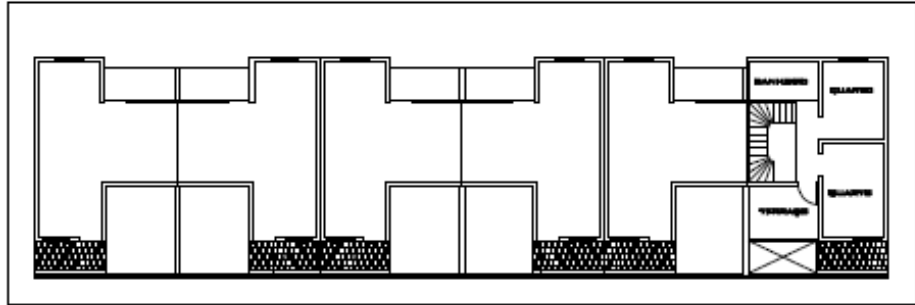

1º PAVIMENTO

ELEVAÇÕES



FACHADA POSTERIOR

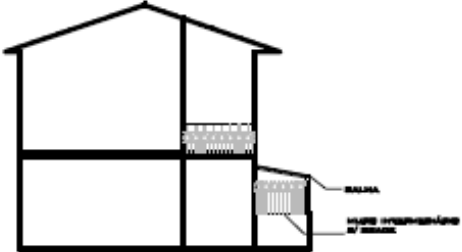
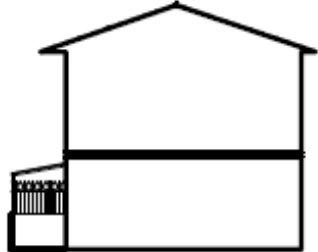

SALA
ÁREA DE SERVIÇO DO SOBRADO

EXEMPLO DE FECHAMENTO POSTERIOR DOS SOBRADOS, COM COBERTURA DA ÁREA DE SERVIÇO, ADIÇÃO DE BANHEIRO E QUARTO NO 1º PAVIMENTO

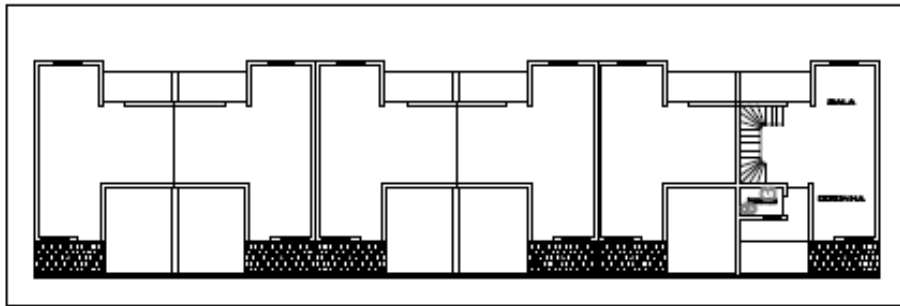

TÉRREO

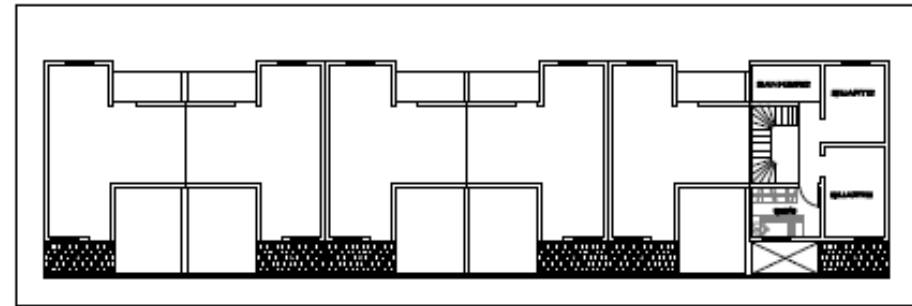

1º PAVIMENTO



FACHADA POSTERIOR

ELEVAÇÕES

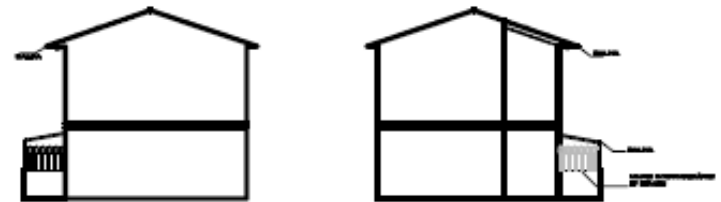

EXEMPLO DE FECHAMENTO POSTERIOR DOS SOBRADOS, COM COBERTURA DA ÁREA DE SERVIÇO, ADIÇÃO BANHEIRO E TERRAÇO COM MURO DE TIJOLOS ESPAÇADOS

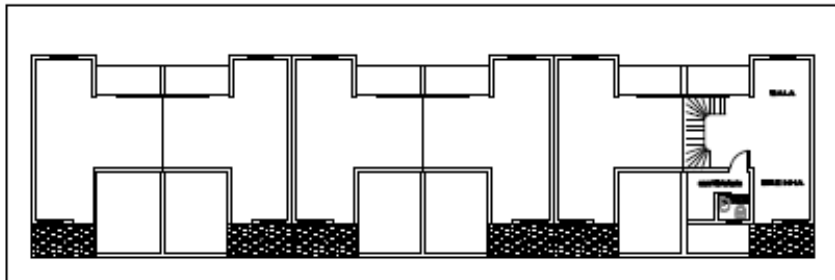

TÉRREO

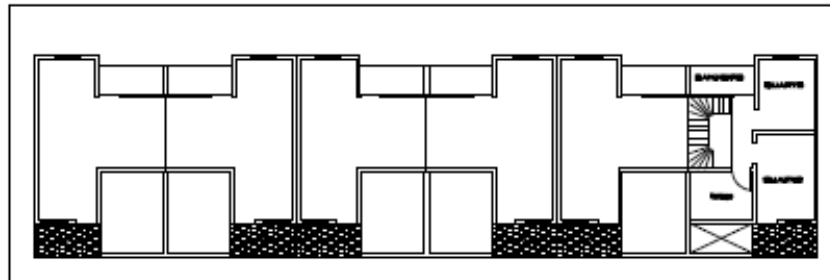

1º PAVIMENTO

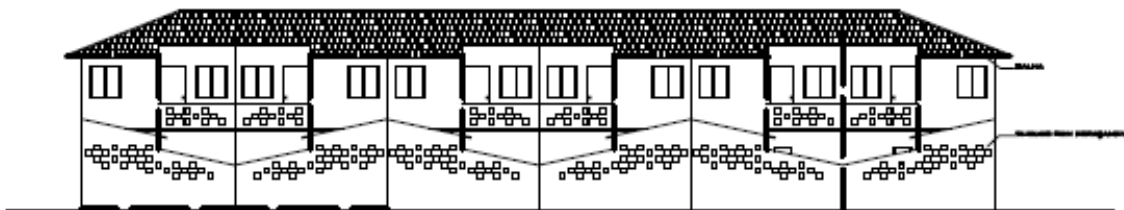

FACHADA POSTERIOR

ELEVAÇÕES

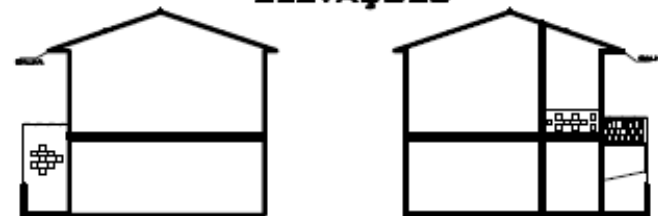

DETALHAMENTO DOS TIJOLOS ESPAÇADOS

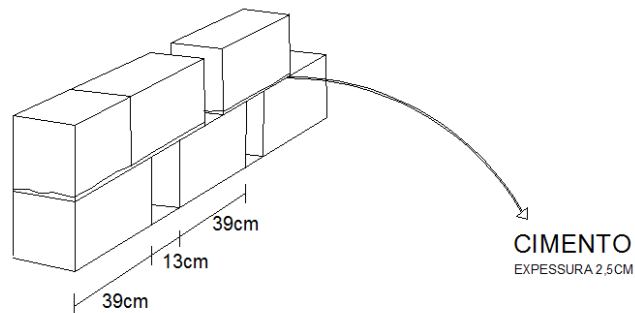

EXEMPLO DE FECHAMENTO POSTERIOR DOS SOBRADOS, COM COBERTURA DA ÁREA DE SERVIÇO, ADIÇÃO BANHEIRO E QUARTO COM MURO DE TIJOLOS ESPAÇADOS

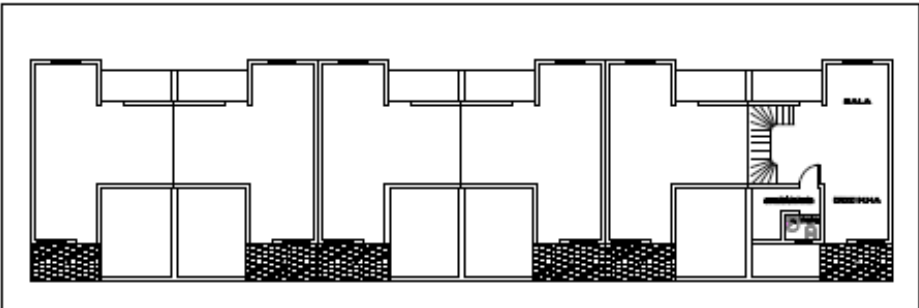

TÉRREO

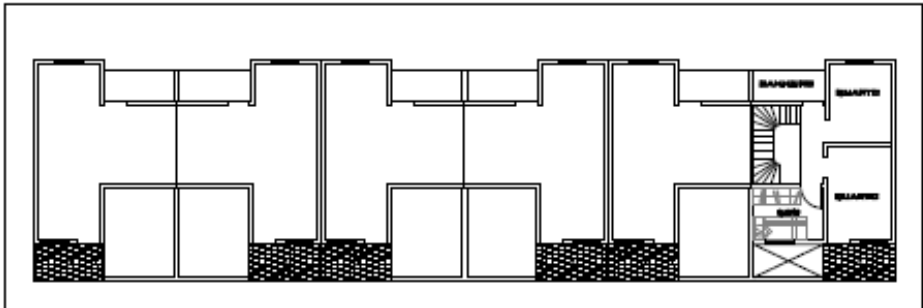

1º PAVIMENTO

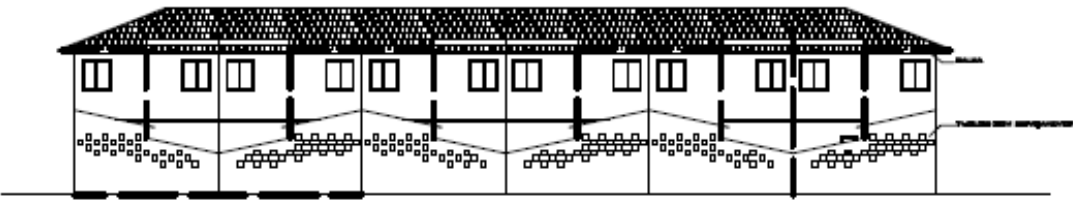

FACHADA POSTERIOR

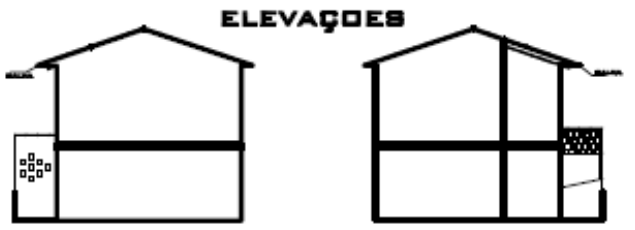

ELEVAÇÕES

DETALHAMENTO DOS TIJOLOS ESPAÇADOS

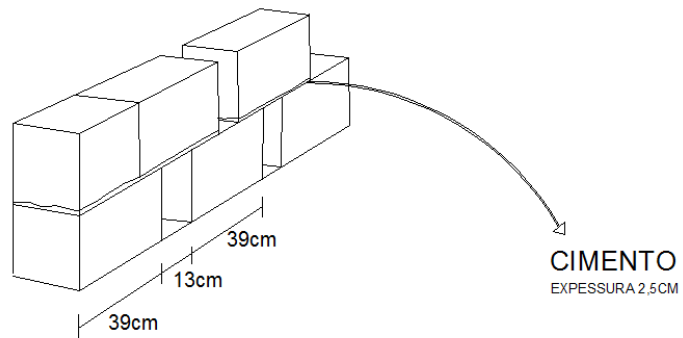

GRUPO - Programa UNESP para o desenvolvimento sustentável de São o Luís do Paraítainga

ALUNOS COLABORADORES:

ARIELA CARTELLI

BÁRBARA VETORAZZO

BRUNO CARRON

CAIO YASHIMA

EDUARDO NISTA

HUGO CALEIRAS

KATIA LIBÂNIO

RAUL SANCHES

RAQUEL BRAGAGNOLO

RENATA SARTORI

VICTOR SOTORILLI

COORDENADOR: PROF^o Dr. JOSÉ XAIDES ALVES DE SAMPAIO